

Diffusore in policarbonato di elevata qualità con sistema click, resistente ai raggi UV e agli urti.
 Diffusore trasparente o acidato.
 Led alta potenza.
 Grado di protezione IP40.
 Corretta dissipazione del calore per una lunga durata dei LED.
Esempi di applicazioni:
 Per cucine e sottopensili; Soffitti, mensole, scaffali; Soffitti in cartongesso; Interior lighting design; Illuminazione per interni.

Polycarbonate high-quality diffuser with system clicks, UV resistant and shock.
 Clear or satin diffuser.
 Led Strip high yield.
 Degree of protection IP40.
 Heat dissipation for long life of LEDs.
 Examples of applications:
 For kitchens and roofs; Ceiling, shelves, racks; Plaster Ceiling; Interior lighting design; Interiors lighting.

Hochwertiges Polykarbonat Diffuser mit Klicks System, UV-beständig und Schock.
 Klar oder gefrostet Diffusor.
 Led-Streifen hohe Leistung.
 Schutzart IP40.
 Wärmeabgabe für eine lange Lebensdauer der LEDs.
 Beispiele für Anwendungen:
 Für die Küche und Hängend; Decken, Regalen; Gipskartondecken; Innenbeleuchtung Design; Innenbeleuchtung.

Diffuseur en polycarbonate de haute qualité avec système Clics, résistant aux UV et aux chocs.
 Diffuseur transparent ou mat.
 Led bande à haut rendement.
 Degré de protection IP40.
 Dissipation de la chaleur pour une longue vie de LED.
 Exemples d'applications:
 Pour les cuisines et les pendants; Plafonds et étagères; Plafonds en Placoplatre; L'éclairage intérieur de design; Éclairage intérieur.

Policarbonato de alta calidad clics del sistema, los rayos UV y el shock.
 Transparente y difusor esmerilado.
 Led de alta potencia.
 Grado de protección IP40.
 Disipación de calor para una larga vida de los LEDs.
 Ejemplos de aplicaciones:
 Bajo el techo de las cocinas; Techos, repisa, estantes; Techos de yeso; La iluminación interior de diseño; Iluminación interior.

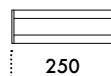
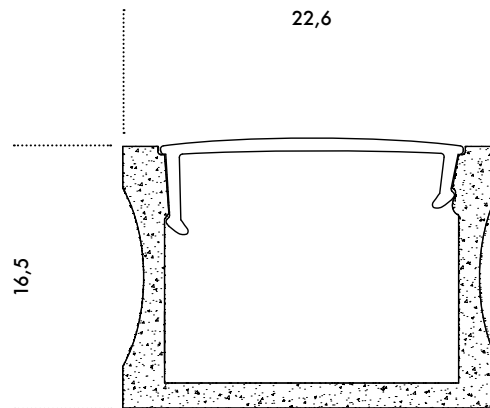

struttura - surface finish Struktur - monture - estructura	diffusore - diffuser - Diffusor diffuseur - difusor		W	articolo - article - Artikel article - articulo
AA ALLUMINIO ANODIZZATO	P2 TRASPARENTE	P4 SATINATO	3,3	258 250 3

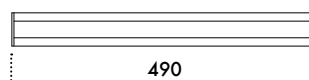

struttura - surface finish Struktur - monture - estructura	diffusore - diffuser - Diffusor diffuseur - difusor		W	articolo - article - Artikel article - articulo
AA ALLUMINIO ANODIZZATO	P2 TRASPARENTE	P4 SATINATO	6,6	258 490 6

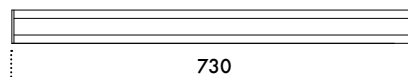



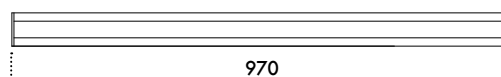







struttura - surface finish Struktur - monture - estructura	diffusore - diffuser - Diffusor diffuseur - difusor		W	articolo - article - Artikel article - articulo
AA ALLUMINIO ANODIZZATO	P2 TRASPARENTE	P4 SATINATO	9,9	258 730 10



struttura - surface finish Struktur - monture - estructura	diffusore - diffuser - Diffusor diffuseur - difusor		W	articolo - article - Artikel article - articulo
AA ALLUMINIO ANODIZZATO	P2 TRASPARENTE	P4 SATINATO	13,2	258 970 13



CLASSE III
 DRIVER
 A
 RICHIESTA
 0,50 mt
 0,054 Kg
 0,158 Kg
 0,210 Kg
 0,261 Kg



Colori Ral e misure personalizzate su richiesta

RAL colors and custom sizes on request

RAL-Farben und Sondergrößen auf Anfrage

Les couleurs RAL et les formats personnalisés sur demande

RAL colores y tamaños personalizados por encargo



ACCESSORI - ACCESSORIES - ZUBEHÖR - ACCESSOIRES - ACCESORIOS

